

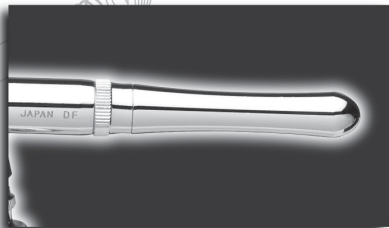

iwata ***Revolution***

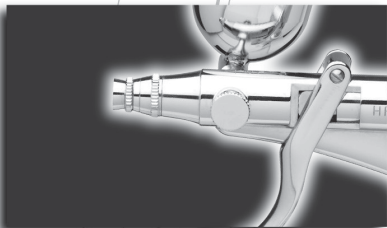

IWATA TR1 & TR2 MANUAL & PARTS GUIDE

NEED ASSISTANCE

If you have any issues or warranty service questions, contact your local ANEST IWATA affiliate before returning to your place of purchase.

ANEST IWATA-MEDEA, INC.

Portland, Oregon U.S.A.
+1-503-253-7308 (M-F)
info@iwata-medea.com
www.iwata-medea.com

ANEST IWATA SOUTH-EAST ASIA CO., LTD.

Bangkok, Thailand
+66-(0)-2643-2870
www.anest-iwatasoutheastasia.com

ANEST IWATA SOUTH AFRICA (PTY) LTD.

Johannesburg, Republic of South Africa
+27-11-463-2169/2265/2223
www.anest-iwata.co.za

ANEST IWATA CORPORATION

Yokohama, Japan
+81-(0)45-591-1111
www.anest-iwata.co.jp

ANEST IWATA STRATEGIC CENTER

Cardano al Campo, Italy
+39-0331-733120
www.anest-iwataeu.com

ANEST IWATA SHANGHAI

Shanghai, China
+86-(0)21-6407-9713 / 15 / 16
www.anest-iwata-sh.com

ANEST IWATA RUS LLC

Moscow, Russia
+7-495-938-77-28
www.anestiwata.ru

ANEST IWATA AUSTRALIA PTY LTD.

Mt. Druitt, NSW
+61-(02)-9853-2000
www.anest-iwata.com.au

ANEST IWATA (U.K.) LTD.

Neots Cambs, England
+44-(0)1480-405419
www.anest-iwata.co.uk

ANEST IWATA MOTHERSON LTD.

Uttar Pradesh, India
+91-(0)120-4600500 / 14 / 17
www.aircompressors.com

CENTURY TRADING CO., LTD.

Seoul, Korea
82-2-2163-0300
www.centtrading.co.kr

Congratulations on your purchase of an Iwata *Revolution*[™] airbrush, a versatile, reliable and dependable airbrush. The Revolution was designed for the new airbrush user or hobbyist seeking Iwata's famous superior spray quality combined with multi-purpose versatility.

**VALUE,
QUALITY & PERFORMANCE**

distinguish these airbrushes as Revolution!

iwata
Revolution



ONLY FROM IWATA-MEDEA

Iwata airbrushes are designed for demanding professionals. Modern precision machining and carefully selected materials used in the manufacturing process ensure consistent high performance and long life. Each Iwata airbrush is spray-tested before shipment to assure maximum performance and adherence to Iwata's strict quality standards. To maintain your Revolution at its peak performance, proper care and attention must be observed.

IWATA REVOLUTION TRIGGER GUNS

Comfort combined with ultra-smooth performance create an ideal team for custom-automotive painting. Revolution Trigger Guns deliver total paint and spray control, just like conventional airbrushes, while offering the same comfort and feel of larger spray guns. Solvent-based paints can't harm the airbrush thanks to the PTFE needle-packing seal, while the Pistol-Grip Filter defends against moisture in the airhose.



Iwata Revolution TRI

- *Pistol trigger design allows fixed, dual-action operation.*
- *Internal mix airbrush.*
- *Ergonomic, balanced handle for easy, level spraying.*
- *Spray pattern .75" down to hairlines.*
- *Replaceable, internal PTFE needle packing for use with solvent-based paints.*
- *R3 head system*
- *FA450 Iwata Pistol Grip Filter defends against moisture.*
- *Side-feed airbrush design allows the use of side-feed bottles and cups.*
- *.25 oz side-mounted color cup.*



Iwata Revolution TR2

- *Pistol trigger design allows fixed, dual-action operation.*
- *Internal mix airbrush.*
- *Ergonomic, balanced handle for easy, level spraying.*
- *Spray pattern 1.5" down to fine lines.*
- *Replaceable, internal PTFE needle packing for use with solvent-based paints.*
- *R5 head system*
- *FA450 Iwata Pistol Grip Filter defends against moisture.*
- *Side-feed airbrush design allows the use of side-feed bottles and cups.*
- *.5 oz side-mounted color cup.*

GETTING STARTED REVOLUTION TRI, TR2

Compressor

Choose an appropriate compressor for your Revolution airbrush. The Iwata Sprint Jet and Smart Jet compressors are good beginner's choices and will provide approximately 30 psi of air pressure to the Revolution. 30 psi provides a finely atomized background spray in addition to controllable fine detail performance.

Assembly

1. Screw the airhose onto the compressor.
2. Screw the airhose onto the airbrush.

3. If using a Power Jet, Power Jet Lite, or Power Jet Pro compressor, adjust the pressure to between 30 and 45 psi.
4. Check for any air leaks in the compressor or airhoses
5. Place a few drops of cleaner into the bowl.
6. Point the airbrush away from you.
7. Pull back on the trigger (#9) a little to start the flow of air through the airbrush.
8. Pull back on the trigger all the way to fully open the nozzle of the airbrush.
9. Spray cleaning solution through the airbrush to rinse out any residual pre-testing pigment.

GENERAL OPERATION REVOLUTION TRI, TR2

Spraying

1. Pull the trigger (#9) back slightly and only the air will come out.
2. Pull the trigger back more until paint starts to spray in small amounts.
3. Pulling the trigger back further releases even more paint until the trigger is pulled as far as it can go.

Fine-Line Spray

1. Pull the trigger (#9) slightly back to start airflow.
2. Position the airbrush close to the surface, between 1/16 and 1/2 inch is common.

3. Pull the trigger back more to start the flow of paint.

Stippling

Iwata airbrushes are designed to produce a wide range of stippling textures.

1. Unscrew the needle cap (#1)
2. Unscrew the nozzle cap (#2)
3. Adjust the air pressure between 5 and 50 psi.

Lower air pressure will give you coarse stipple whereas higher pressure will provide a fine stipple effect. Paint viscosity will also effect the stippling texture.

Line thickness can be controlled by adjusting the distance between the airbrush and the surface and also by varying the paint flow by manipulating the trigger's position.

An extremely narrow line can be obtained by carefully removing the needle cap (#1) and positioning the airbrush closer to the surface.

CAUTION: The needle and nozzle are very delicate. Even a slight bend on the tip of the needle can adversely effect the spray pattern.

Wide-Line and Background Spraying

1. Pull the trigger (#9) slightly back to start airflow.
2. Position the airbrush further away from the surface, from ½ to 6 inches is common.
3. Pull the trigger back much further releasing more paint to cover the bigger area.

Increase the distance between the airbrush and painted surface to control the line's width. Increasing the air pressure will also effect the spray width. The Revolution's maximum usable line width is approximately 2½ inches.

Air Pressure

For the Revolution, working pressures generally vary between 20 and 60 psi, depending on what type of work is being

done and what textures are desired. A good working pressure may average around 25 psi. The viscosity of the paint and your desired spray characteristics will also effect your ideal pressure. As a general rule, larger amounts of paint, or thicker paints, will be sprayed with higher pressures. **WARNING:** Do not exceed 100psi

Paint Preparation

For non-specific airbrush paints proper preparation, including filtering the paint through a nylon mesh, is recommended for best performance. Paint should be thinned with its proper solvent. It is best to prepare paint relatively thin and make repeated passes across the work to achieve the desired shade. This will also improve the quality of your work and decrease the cleaning time of your airbrush.

Safety Tips

- Always spray in a well ventilated area.
- Do not spray solvent-based (flammable) paints around open flames.
- Use the appropriate respirator to safely filter out the paint vapors particular to the kind of paint you are using.
- Wear eye protection to prevent paint contact with eyes.
- Never use air pressure that exceeds the airbrush's limit. (100 psi)

MAINTENANCE

Choose an Cleaning the Airbrush Between Colors

1. Dump out the color cup's excess paint.
2. Rinse the cup with the appropriate cleaning solution.
3. Use a paper towel to wipe out any left-over paint.
4. Fill the bottom of the cup with cleaner.
5. Spray cleaner until the spray is clear.
6. Add the next color to the color cup.
7. Repeat cleaning procedure when finished.

Cleaning the Needle

1. Unscrew the handle (#16) from the airbrush body.
2. Loosen the needle chucking nut (#14).
3. Gently pull the needle (#13) straight out.
4. Fold a soft cloth damp with cleaner over the needle.
5. Rotate the needle to gently wipe the residual paint off.
6. Carefully insert the needle into the airbrush until it seats fully against the nozzle (#3).
7. Tighten the needle chucking nut finger tight.
 - Pull the trigger back and forth to visually confirm the needle's ability to move.
8. Screw the handle back onto the airbrush body.

Before Each Session

Spray water, or the appropriate paint solvent, through the airbrush to make sure the airbrush is working properly.

After Each Session

Or any time the airbrush becomes clogged.

1. Increase the air pressure.
2. Spray cleaning solution for a short time.
3. Clean the needle if necessary

Cleaning the airbrush this way helps clean the paint passage, the nozzle, and the needle thoroughly.

Periodically

To ensure smooth main lever action lubricate the needle (#17) and the main lever mechanism (#10 or #11) regularly.

1. Unscrew the handle (#17 or #18).
2. Loosen the needle chucking nut (#16).
3. Remove the needle.
4. Coat the needle lightly with a high-quality lubricant, like Medea Super Lube.
5. Wipe the needle with a soft, clean cloth, leaving a light coat of lube behind.
6. Re-insert the needle gently into the airbrush.
7. Tighten the needle chucking nut.
8. Screw the handle onto the airbrush body.
9. Drip 1 drop of lube into the slot directly behind the main lever and as close to the main lever as possible.

DO NOT over-lube the needle or the main lever mechanism, since it is possible to transfer excess lube into the nozzle causing severe paint flow problems.

DO NOT use light machine oil or WD-40 for lubrication. These will cause the needle to stick as it moves through the needle packing o-ring.

CAUTION: If it becomes absolutely necessary to dismantle the airbrush remember that in most situations tools are not needed. DO NOT use pliers. If needed use the provided wrench to unscrew the head cap (#3).

TROUBLESHOOTING PROCEDURES

Symptom	Problem	Solution
•Bubbles in color cup or bottle	•Loose nozzle cap •Improper nozzle to body connection •Cracked or damaged nozzle	•Tighten (#2) finger tight •See nozzle (#3) to reseat the nozzle •See nozzle (#3) to replace the nozzle
•Double line	•Dried paint on needle tip (Tip-Dry) •Dirty airbrush •Debris on nozzle tip •Bent needle •Cracked or damaged nozzle	•See cleaning the needle •See cleaning the airbrush between colors •See cleaning the needle •See nozzle (#3) and clean nozzle with toothpick •See needle (#15) to replace needle •See nozzle (#3) to replace the nozzle
•Not spraying	•Loose needle chucking nut •Needle stuck •Improper air pressure •Paint too thick •Cup vent hole is plugged •Clogged nozzle •Cracked or damaged nozzle	•Finger tighten (#16) •Pull/break-free needle (#15) •See specific compressor instructions to raise or lower the air pressure •See paint preparation •Use pushpin to unclog vent hole •See nozzle (#3) and clean nozzle with toothpick •See nozzle (#3) to replace the nozzle

TROUBLESHOOTING PROCEDURES

Symptom	Problem	Solution
•Skipping	•Dried paint on needle tip (Tip-Dry) •Pigment too thick •Air pressure too high •Improper nozzle to body connection •Dirty airbrush •Cracked or damaged nozzle	•Clean with cotton swab dipped in cleaner •See paint preparation •See specific compressor instructions to lower the air pressure •See nozzle (#3) to reseal the nozzle •See cleaning the airbrush between colors •See cleaning the needle •See nozzle (#3) to replace the nozzle
•Spattering	•Dried paint on needle tip (Tip-Dry) •Pigment build-up in needle cap •Air pressure too low •Pigment too thick •Dirty airbrush	•Clean with cotton swab dipped in cleaner •Unscrew #1 and clean with cotton swab •See specific compressor instructions to raise the air pressure •See paint preparation •See cleaning the airbrush between colors •See cleaning the needle
•Trigger sticks (back and forth)	•Dirty airbrush	•See cleaning the airbrush between colors •See cleaning the needle
•Trigger sticks (up and down)	•Dried out air valve packing o-ring	•Lube trigger shaft

REPLACEMENT PARTS AND ACCESSORIES

Nozzle (#3)

In time, the nozzle may wear or be damaged and may need to be replaced.

1. Unscrew the handle (#16).
2. Loosen the needle chucking nut (#14).
3. Gently pull the needle (#13) part way back. It doesn't need to be fully pulled out.
4. Unscrew the nozzle cap (#2)
5. Unscrew nozzle counter-clockwise with provided wrench.
6. Screw new nozzle into the airbrush body with your fingers.
7. Slightly tighten the nozzle with the provided wrench.
 - **DO NOT OVER TIGHTEN!**
8. Screw the nozzle cap onto the airbrush body.
9. Push needle all the way forward until it seats with new nozzle.
10. Tighten the needle chucking nut.
11. Screw the handle onto the airbrush body.

TIP: Keep a spare nozzle on hand for unforeseen accidents.

Needle (#13)

Iwata needles are made of precision ground and hardened stainless steel that will withstand prolonged usage. They are, however, subject to easy physical damage because of the long tapered, extremely fine tip. If the needle point becomes severely bent, it must be straightened before pulling it back through the nozzle. If not, the bent needle might damage the nozzle as it's pulled through. TIP: Keep a spare needle on hand for unforeseen accidents.

Quick Disconnect (Optional Accessory)

A quick disconnect joint is screwed onto the airhose and a quick disconnect adapter is screwed onto each airbrush. When using multiple airbrushes the quick disconnect joint facilitates changing airbrushes on the same airhose quickly.

Side-Feed Color Bottles and Cups (Optional Accessory)

Several bottle sets and styles are available. From Crystal Clear bottles for water-based paints to the solvent-impervious High Strength translucent bottles, Iwata-Medea offers a wide assortment of bottles for every application. Chrome-plated side mounted cups are also available in 1/8 and 1/4 oz sizes.

Color Bottles (Optional Accessory for BCR and SAR)

Several bottle sets and styles are available. From Crystal Clear bottles for water based paints to the solvent impervious High Strength translucent bottles, Iwata-Medea offers a wide assortment of bottles for every application.

Pistol Grip Moisture Filter

The Iwata-Medea Pistol Grip Moisture Filter delivers clean, dry air to your airbrush. Miniature in size, the super-fine, 5-micron filter element performs like a full-size filter separator.

The clear filter bowl allows visual inspection of built up moisture. Release the water by pulling the spring-loaded release valve.

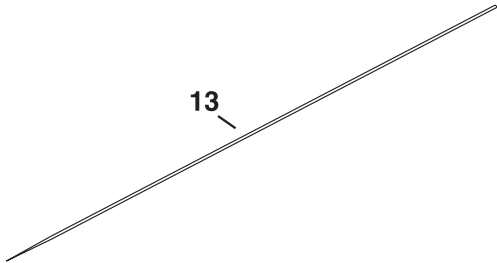
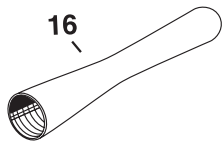

3



Pistol-Grip Filter

The Iwata Revolution

TR1 and TR2 Series

Airbrush features

the Iwata-Medea

Pistol-Grip Filter.

iwata
MEDEA

ANEST IWATA-MEDEA, Inc.

For clean, dry air-flow.

Attaching directly onto the airbrush, the Iwata-Medea Pistol-Grip Filter is the final defense to deliver clean, dry air to your airbrush. Miniature in size, the super-fine, 5-micron filter element performs like a full-size moisture separator.

The clear filter bowl allows a visual inspection of built-up moisture and is evacuated through a spring-loaded release valve – without taking the filter off the airbrush.

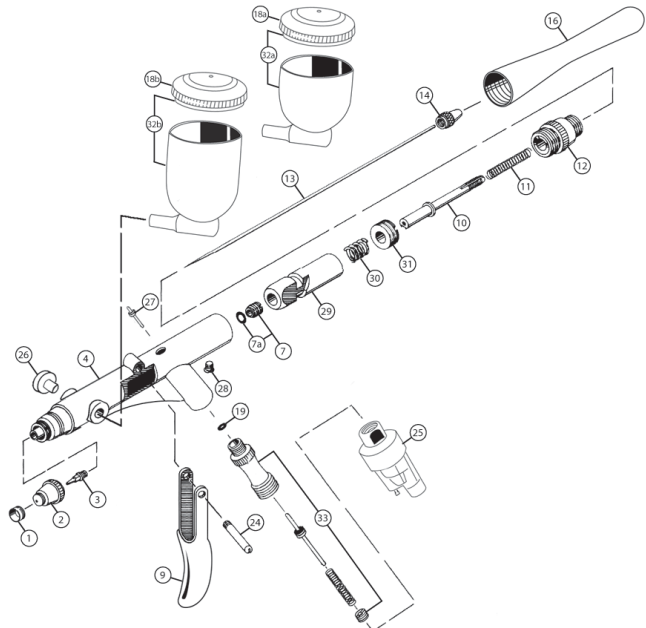

Ergonomically designed, the Pistol-Grip Filter provides for many comfortable hours of spraying.

40



— IWATA REVOLUTION TR1/TR2 AIRBRUSHES • MASTER PARTS LIST —

#	ITEM DESCRIPTION	PRICE CODE	ITEM #	HP-TR1	HP-TR2	ALSO FITS
1	Needle Cap	R3	A 17013	■	opt	
		R5	A 17011	opt	■	BCR, CR, SAR
2	Nozzle Cap	R3	C 17022	■	opt	AR, BR
		R5	C 17021	opt	■	BCR, CR, SAR
3	Nozzle	G	17043	opt	opt	
		R3	C 17042	■	opt	AR, BR
		R5	C 17041	opt	■	BCR, CR, SAR
4	Body*		N/A	■	x	
			N/A	x	■	
7	Needle Packing Screw	 C	17252	■	■	
7a	Needle Packing (O-Ring)	A	11502	■	■	
9	Trigger	I	17141	■	■	
10	Needle Chucking Guide	F	17152	■	■	
11	Needle Spring	A	17703	■	■	
12	Spring Guide	H	17702	■	■	
13	Needle	R3	C 17174	■	opt	
		R5	C 17175	opt	■	
14	Needle Chucking Nut	A	11202	■	■	All
16	Handle	D	17192	■	■	SAR

#	ITEM DESCRIPTION	PRICE CODE	ITEM #	HP-TR1	HP-TR2	ALSO FITS
18a	Cup Lid	C	17181	■	x	CR, CS, C, C+, CH, CM-C
18b	Cup Lid	F	17182	x	■	
19	Valve Packing (O-Ring)	A	11451	■	■	HP, HP+, HI-LINE
24	Trigger Screw	C	17142	■	■	
25	Pistol-Grip Filter	F	F A450	■	■	All
26	Blanking Cover	A	10452	■	■	SBS, SB, SB+, CM-SB
27	Valve Piston	C	17131	■	■	
28	Main Body Ring Screw	A	17312	■	■	
29	Slide Cam	I	17301	■	■	
30	Slide Cam Spring	B	17302	■	■	
31	Main Body Ring	 D	17311	■	■	
32a	Gravity Side Cup	1/3 oz	G 17201	■	x	SBS, SB, SB+, CM-SB
32b	Gravity Side Cup	1/2 oz	G 10706	x	■	SBS, SB, SB+, CM-SB
33	Air Valve Set 2pcs. Spanner	 G	17121	■	■	
		A	11651	■	■	

 **CALIFORNIA PROP 65 WARNING:** Certain products identified with this symbol and offered for sale in this catalog contain lead, a chemical known to the State of California to cause cancer, birth defects and other reproductive harm.

■ = yes X = no opt = optional

*Replacement parts not available.



All Iwata airbrushes are warranted against all manufacturing defects of material and manufacture or workmanship for a period of FIVE years from date of purchase. This warranty does not cover needles, nozzles, o-rings and internal packings since these parts need to be replaced occasionally due to normal wear. Any other parts or materials that are or become defective so as not to be usable within this period will be repaired or replaced. This warranty does not cover damage caused by negligence or airbrushes which have been altered or abused in any way.

iwata

by **ANEST IWATA**

WWW.IWATA-AIRBRUSH.COM